

PMCE-XXXX EMI/RFI COMMON MODE LINE FILTERS

MEDIUM & HI POWER

- ① Rated Voltage: 250Vac, 45/400Hz
- ② < 50°C Temp Rise & Rated Current ⁽¹⁾
- ③ Operating Temp -40 to +80 °C
- ④ Low Profile Construction
- ⑤ 3750Vrms Isolation
- ⑥ Insulation Resistance @ 500Vdc >100MΩ

ELECTRICAL SPECIFICATIONS AT 25°C - OPERATING TEMPERATURE RANGE -40°C TO +80°C

PART NUMBER	RATED RMS Current Amps rms	Load VA @ RMS Line		INDUCTANCE @ 1KHz (mH Min.)	DCR EACH WINDING (Ohms Max.)	PACKAGE
		115V	230V			
PMCE-0470	0.75	86.25	172.50	47.0	0.720	E25.4
PMCE-0330	1.00	115.00	230.00	33.0	0.550	E25.4
PMCE-0160	1.50	172.50	345.00	16.0	0.250	E25.4
PMCE-0100	1.75	201.25	402.50	10.0	0.170	E25.4
PMCE-0056	2.25	258.75	517.50	5.6	0.080	E25.4
PMCE-0033	2.75	316.25	632.50	3.3	0.055	E25.4
PMCE-0015	3.50	402.50	805.00	1.5	0.032	E25.4
PMCE-3470	1.75	201.25	402.5	47.0	0.520	E35
PMCE-3330	2.00	230.00	460.00	33.0	0.375	E35
PMCE-3220	2.50	316.25	632.50	22.0	0.250	E35
PMCE-3100	3.50	402.50	805.00	10.0	0.150	E35
PMCE-3056	4.50	517.50	1035.0	5.6	0.090	E35
PMCE-3033	5.50	632.50	1265.0	3.3	0.050	E35
PMCE-3015	7.00	805.00	1610.0	1.5	0.030	E35

Notes:

- (1) Temperature Rise is specified at maximum continuous current. Lower currents will result in reduced temperature rise. Design point is < 50°C rise at rated current.

APPLICATION

TYPICAL APPLICATION CIRCUIT

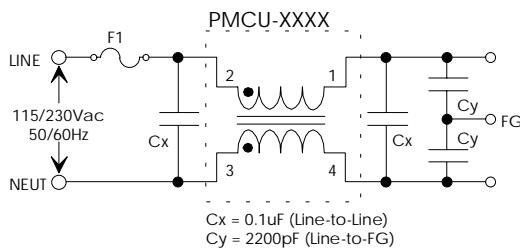

SCHEMATIC

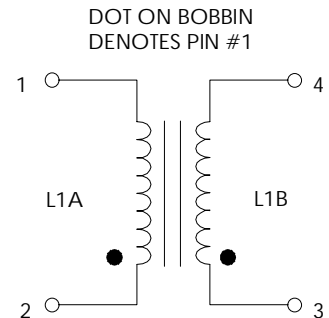



**Premier
Magnetics Inc.**

"INNOVATORS IN MAGNETICS TECHNOLOGY"

PMCE-XXXX EMI/RFI COMMON MODE LINE FILTERS

PMCE-0XXX E25.4

Dimensions in inches (mm)

PART IS REVERSIBLE.
IT CAN BE INSERTED INTO PCB EITHER WAY.

DOT ON BOBBIN
DENOTES PIN #1

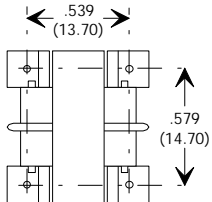
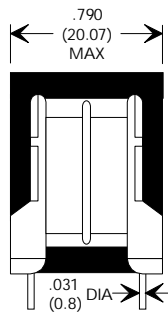
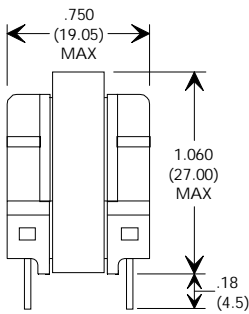
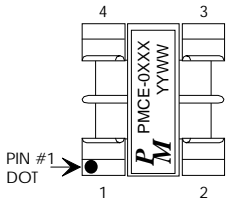
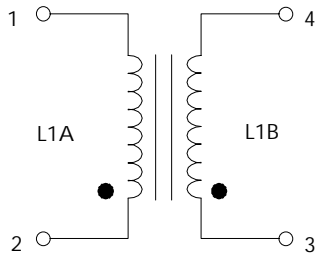

PMCE-3XXX E35

Dimensions in inches (mm)

PART IS REVERSIBLE.
IT CAN BE INSERTED INTO PCB EITHER WAY.

DOT ON BOBBIN
DENOTES PIN #1

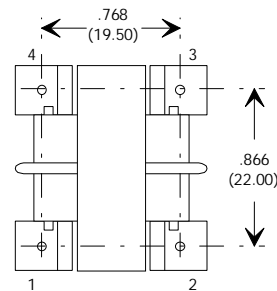
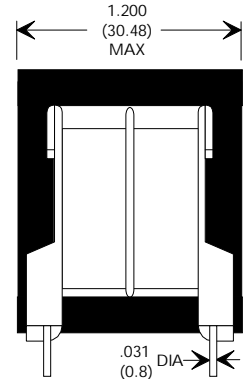
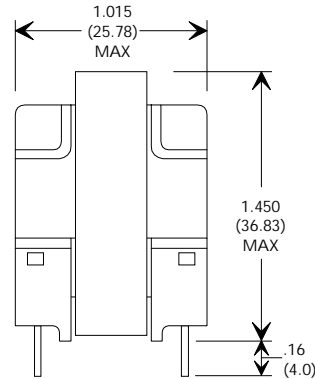
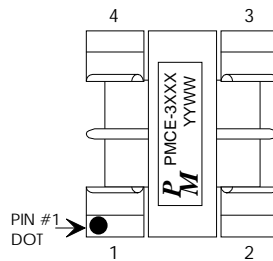
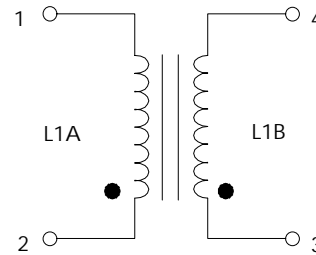

Specifications subject to change without notice.

pmce 10/98



Basingstoke Road, Spencers Wood, Reading, Berks, RG7 1PW
Tel: 0118 976 9000 www.sequoia.co.uk